

# The Solution for Your Needs

## How to choose your ball valves?

### Which kind of valve do you need ?

- **Ball Valves**



- **Needle Valves**



- **Butterfly Valves**



Represents an interesting economical alternative compared with a ball valve

- **Axial Valves**



### What are the conditions of use ?

- Pressure
- Temperature inside the system
- Sealing requirements
- Flow requirements
- 2 ways or 3 ways
- Normally closed / Normally open ?

### What type of fluid is being conveyed ?

- Compatibility of materials with the fluid : body & seals

### Which technology is required to connect your ball valves ?

- Compression
- Threaded
- Push-in connection

### Have you considered the additional product requirements ?

- Compression fittings
- Tubing
- Solenoid valves

### What is your application environment ?

- Internal or external environment
- Risk of shocks
- Air quality
- Regulations
- Corrosion risk
- Frequency of operation

### What other functions are required ?

- Lockable
- Vented
- Frequency of operation
- Electric or pneumatic

## Part Number Identification

**0402 04 10**

Valve type

0400  
0401  
0402  
...















Length

04 = 4 mm  
05 = 5 mm  
...  
40 = 40 mm

Thread

10 = 1/8"  
13 = 1/4"  
...  
48 = 2"

# Product Specifications Overview

	Materials	Fluids	Maximum Pressure (bar)	Temperature		Page
				Min.	Max.	
<b>Industrial Valves</b>						
 <p><b>Universal and Customised Series Ball Valves</b></p>	Nickel-plated forged brass	Compressed air Other fluids (see compatibility chart at the end of this chapter)	40	-40°C	+80°C +100°C: please contact us	<b>444</b>
 <p><b>Universal Series, Vented</b></p>	Nickel-plated forged brass	Compressed air Other fluids (see compatibility chart at the end of this chapter)	40	-20°C	+80°C	<b>447</b>
 <p><b>Universal Series, Lockable</b></p>	Nickel-plated forged brass, galvanised steel and epoxy locking system	Compressed air Other fluids (see compatibility chart at the end of this chapter)	40	-40°C	+80°C	<b>448</b>
 <p><b>Universal Light Series</b></p>	Forged brass or nickel-plated forged brass	Compressed air Other fluids (see compatibility chart at the end of this chapter)	20	-20°C	+80°C	<b>449</b>
 <p><b>DVGW Series Ball Valves</b></p>	Nickel-plated brass	Compressed air Other fluids (see compatibility chart at the end of this chapter)	40	-40°C	+170°C	<b>451</b>
 <p><b>Standard Series Ball Valves</b></p>	Nickel or chromium plated brass	Compressed air Other fluids (see compatibility chart at the end of this chapter)	30	-20°C	+130°C	<b>452</b>
 <p><b>Stainless Steel Series Ball Valves</b></p>	Stainless steel 316L	All fluids	35	-20°C	+150°C	<b>454</b>
 <p><b>High Pressure Ball Valves</b></p>	Zinc-plated brass	Compressed air, lubricants, gases	300	-15°C	+80°C	<b>456</b>
 <p><b>Mini Series Ball Valves</b></p>	Technical polymer/ Nickel-plated brass	Compressed air	10	-20°C	+80°C	<b>457</b>
 <p><b>LIQUIfit® Ball Valves</b></p>	Polypropylène	Beverages, water, industrial water, CO <sup>2</sup> , inert gases	10	-15°C	+100°C	<b>459</b>
 <p><b>Brass Needle Ball Valves</b></p>	Shot-blasted forged brass nickel-plated	Compressed air, water, industrial fluids Other fluids: please contact us	120	-20°C	+100°C	<b>461</b>
 <p><b>Stainless Steel Needle Valves</b></p>	Stainless steel 316L	All fluids	400	-20°C	+180°C	<b>460</b>
 <p><b>Butterfly Valves</b></p>	Shot-blasted forged brass nickel-plated	Compressed air, abrasive fluids	16	-20°C	+80°C	<b>462</b>
 <p><b>Axial Valves</b></p>	Nickel-plated brass	Compressed air, water, industrial fluids Other fluids: please contact us	10	-20°C	+135°C	<b>463</b>

# Compatibility Table

The chart below shows the compatibility between valves and fluids along with their pressure and temperature characteristics.

Certain models have a maximum working pressure which differs from that given in this table. In this case, the pressure is shown in the heading for the model number in question.

N.B.: Above 32 mm or 1¼" diameters, divide the maximum pressure by 2.

If the fluid you are using is not shown in this chart, please contact us.

Chemical Description	Maximum Pressure (bar)	Temperature °C		Universal and Light Series	Standard Series	DVGW series
		Min.	Max.			
"Aromatic" hydrocarbons	20	-20	+60			
Acetone and other ketones	20	-20	+60			
Acetophenone	20	-20	+60			
Acetylene - Acetone	20	-20	+60			
Acetylene (gas)	20	-20	+60	●	●	●
Alcohol (100%)	20	-20	Boiling			
Aluminium (liquid suspension, thick)	40	-20	+90	●	●	●
Amyl alcohol	20	-20	Boiling			
Animal fats, greases	20	+5	+200		●	●
Antifreeze or glycol (diluted)	40	-20	+40	●	●	●
Argon (gas) Ar	20	-20	+60	●	●	●
Barium - Hydroxide	20	-20	+40			
Benzaldehyde	20	-20	+60			
Benzene	20	-20	+60			
Benzyl alcohol	20	-20	Boiling			
Borax (pastes or solutions)	20	-20	+60			
Brake fluids (automobile)	20	-20	+90			
Bromochlorotrifluorethane	20	-20	+60		●	●
Butadiene (hydrocarbon)	20	-20	+60			
Butane	20	-20	+60	●	●	●
Butanol	20	-20	Boiling			
Butyl alcohol	20	-20	Boiling			
Butylene (hydrocarbon)	20	-20	+60			
Carbon dioxide gas CO <sub>2</sub>	40	-20	+60	●	●	
Castor oil	40	-20	+90	●	●	
Compressed air	20	-25	+180	●	●	●
Creosotes	20	-20	+60			
Cresols	20	-20	+60			
Crude oil	20	-20	+40			
Cutting oil	40	-20	+90	●	●	
Decalin (hydrocarbon, solvent)	20	-20	+60			
Detergents (solutions)	20	-20	+100			
Diacetone alcohol	20	-20	Boiling			
Diesel oils	40	-20	+90	●	●	
Di-Esters	20	-20	+90			
Di-Isobutylene	20	-20	+60			
Di-Pentane	20	-20	+60			

The above recommendations are given in good faith. However, since each application is different, it is advisable to undertake tests in actual working conditions.

# Compatibility Table

Chemical Description	Max. Pressure (bar)	Temperature °C		Universal and Light Series	Standard Series	DVGW Series
		Min.	Max.			
Di-Pentene (solvents, varnish)	20	-20	+60			
Di-Phenyl-Oxide (thin detergents)	20	-20	+60			
Distilled water	40		+90	●	●	●
Edible fats	20	+5	+200		●	
Edible oils	20	+5	+200		●	
Erytrene (see Butadiene)	20	-20	+60			
Ethane (gas) CH <sub>2</sub> CH <sub>3</sub>	20	-20	+60	●	●	
Ethane (hydrocarbon gas)	20	-20	+60			
Ethyl alcohol	20	-20	+60			
Ethylene glycol (antifreeze) - see Glycols	20	-20	+120			
Fatty alcohols	20	-20	Boiling			
Fuel oils	40	-20	+40	●	●	●
Fuels-Diesels	40	-20	+40	●	●	
Gaseous oxygen (ambient air)	20	-20	+40			
Glycerine	20	-20	+40	●	●	
Glycol (for antifreeze, lubricants)	40	-20	+40	●	●	
Graphite in suspension in water, oils and greases	40	-20	+90	●	●	
Greases (from petroleum)	40	-20	+90	●	●	
Helium (gas)	20	-20	+60			
Heptanal	20	-20	+50	●	●	
Hexane (solvent)	20	-20	+60			
Hydraulic oils (petroleum-based)	40	-20	+90	●	●	
Hydrogen (gas)	20	-20	+60			
Inks	20	-20	+60			
Insecticides	20	0	+40	●	●	●
Iso-Butane (aliphatic hydrocarbon)	20	-20	+60			
Iso-Octane	20	-20	+60			
Isopropyl alcohol	20	-20	Boiling			
Krypton (gas) Kr	20	-20	+60	●	●	●
Light water	40		+80	●	●	●
Lighting gas	20	-20	+40			●
Methane (gas) CH <sub>4</sub>	20	-20	+60	●	●	●
Methanol	20	-20	Boiling			
Methyl alcohol	20	-20	Boiling			
Methylated spirit	40	-20	+40	●	●	●
Mineral oils	40	-20	+90	●	●	●
Natural gas	20	-20	+40			●
Natural waxes (vegetable, beeswax, carnauba, Chinese, lignite)	40	-20	+90			
Neatsfoot oil	40	-20	+90	●	●	●
Neon (Gas) Ne	20	-20	+60	●	●	●
Nitrogen (gas) N <sup>2</sup>	40	-20	+90	●	●	●
Oil (petroleum-based) and water emulsions	40	-20	+90	●	●	●

The above recommendations are given in good faith. However, since each application is different, it is advisable to undertake tests in actual working conditions.

# Compatibility Table

Chemical Description	Max. Pressure (bar)	Temperature °C		Universal and Light Series	Standard Series	DVGW Series
		Min.	Max.			
Oils "synthetic"	20	-20	+100			
Ordinary petrol	20	-20	+40	●	●	
Oxygenated water	40	-20	+30			
Paints and relevant solvents	20	-20	+60		●	●
Paraffin oil	40	-20	+90	●	●	●
Paraffins	20	-20	+60	●	●	●
Pentane (liquid hydrocarbon)	20	-20	+60	●	●	●
Pentanol 1 and 2	20	-20	Boiling			
Petrol "super"	20	-20	+40			
Petroleum mineral oils	20	-20	+160			
Phenol (aqueous or alcoholic)	20	-20	+60		●	●
Propane	20	-20	+60	●	●	●
Propanol 1 and 2	20	-20	Boiling			
Propanone 2	20	-20	+60			
Propene or Propylene	20	-20	+60			
Propyl alcohol	20	-20	Boiling			
Propylene or Propene	20	-20	+60			
Rapeseed oil	40	-20	+90	●	●	
Saponifying liquids	20	-20	+30	●	●	●
Seawater	40		+80	●	●	●
Seawater (high temperature)	20		+150			●
Soaps	20	-20	+100			
Soaps (liquid or paste)	40	-20	+40	●	●	●
Sodium carbonate (with water)	20	0	+40	●	●	●
Starch (gels or pastes)	40	+10	+40	●	●	●
Steam	20	-20	+150			
Toluene (terpenic hydrocarbon)	20	-20	+60		●	●
Trichlorethylene	20	-20	+65			
Turpentine	20	-20	+50	●	●	●
Varnish and paints	20	-20	+60		●	●
Vaseline	40	-20	+60	●	●	●
Vaseline oil	40	-20	+90	●	●	●
Water (carbonated)	40		+90	●	●	●
Water (high temperature)	20		+150			●
Xenon (gas) Xe	20	-20	+60	●	●	●
Xylene	20	-20	+60			

The above recommendations are given in good faith. However, since each application is different, it is advisable to undertake tests in actual working conditions.



# Universal Series



The seal wear compensating technology offers reliable and durable sealing, whether under pressure or vacuum.

## Technical Characteristics

- **Compatible Fluids:** Compressed air  
Other fluids: see compatibility chart at the end of this chapter
- **Working Pressure:** Vacuum up to 40 bar, depending on the model
- **Working Temperature:** -40°C to + 80°C

Reliable performance is dependent upon the type of fluid conveyed, component materials and tubing being used.

Guaranteed for use with a vacuum of 755 mm Hg (99 % vacuum).

## Advantages

- Automatic seal wear compensation
- Vacuum resistance
- Ease of operation
- Short, repositionable and exchangeable handles

## Component Materials

### Silicone-free

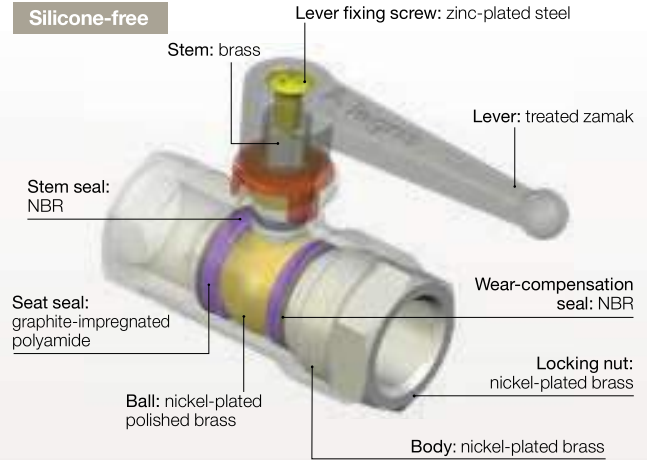

## Regulations

- PED
- RoHS
- REACH

## Installation Options

### Lockable Valves

Our lockable ball valves have been developed in order to prevent potentially dangerous consequences caused by unintended operation. Lockable in different positions, this range meets international safety requirements, such as ISO 4414.

The valves are lockable:

- at one point: models 0432 and 0439
- at three points: models 0436, 0437 and 0438

### Vented Valves

To stop fluid circulation and vent the circuit, 2 venting systems are provided:

- with threaded exhaust, to allow discharge of downstream media
- with pin-hole vent, for applications with no special discharge requirement

Fluid flow direction is indicated by an arrow on the valve body.

### Mountable Valves

On steel plate:

- bulkhead fixing
- complete valve below bulkhead

On frame:

- assemble with bolts

On wooden panel:

- assemble with woodscrews

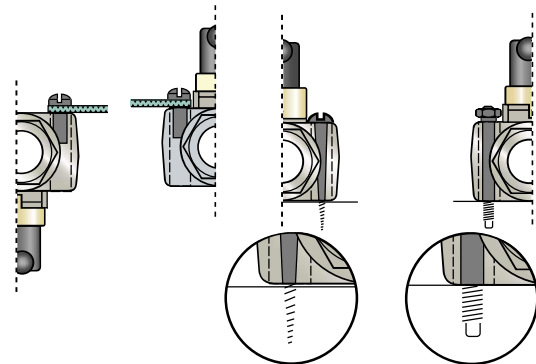

## 0400 2/2 In-Line Ball Valve, Male BSPP Thread

Nickel-plated brass, NBR

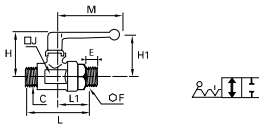

DN	C		E	F	H	H1	J	L	L1	M	Kg
4	G1/8	0400 04 10	7	14	35	29	14	45	25	48	0.094
7	G1/4	0400 07 13	9	19	38	31	19	60	36	48	0.166
10	G3/8	0400 10 17	11	24	45	43	24	70	43	69	0.252
13	G1/2	0400 13 21	12	27	47	44	27	78	45	69	0.324
18	G3/4	0400 18 27	12	38	63	54	39	90	50	108	0.714

Maximum working pressure: 40 bar

## 0411 2/2 In-Line Ball Valve with Connections for Use with Steel Tubing

Nickel-plated brass, NBR

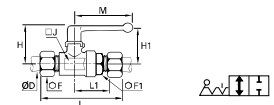

DN	ØD		F	F1	H	H1	J	L	L1	M	Kg
4	6	0411 04 06	14	19	38	31	19	76	30	48	0.173
6	8	0411 06 08	17	19	38	31	19	77	30	48	0.195
7	10	0411 07 10	19	19	38	31	19	78	31	48	0.210
10	12	0411 10 12	22	24	45	43	24	85	36	69	0.310

Maximum working pressure: 40 bar

## 0402 2/2 In-Line Ball Valve, Female BSPP Thread

Nickel-plated brass, NBR

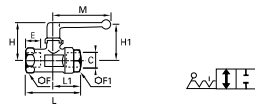

DN	C	Code	E	F	F1	H	H1	L	L1	M	Kg
4	G1/8	0402 04 10	8	14	35	29	44	25	48	0.094	
7	G1/8	0402 07 10	8	19	19	38	31	51	27	48	0.165
	G1/4	0402 07 13	12	19	19	38	31	53	28	48	0.156
10	G3/8	0402 10 17	12	24	24	45	43	59	31	69	0.244
13	G1/2	0402 13 21	15	27	27	47	44	67	34	69	0.292
20	G3/4	0402 20 27	16.5	32	38	63	54	80	39	108	0.655
23	G1	0402 23 34	19	41	46	67	57	94	47	108	1.036
32	G1 1/4	0402 32 42*	21.5	55	60	97	115	112	59	180	2.467
	G1 1/2	0402 32 49*	22	55	60	97	115	120	62	180	2.340
40	G1 1/2	0402 40 49*	22	55	55	104		111	55	190	2.445
	G2	0402 40 48*	26	70	70	104		122	61	190	2.614

\*Models with EC marking  
Maximum working pressure: 40 bar

## 0446 2/2 In-Line Panel-Mountable Ball Valve, Female BSPP Thread

Nickel-plated brass, NBR

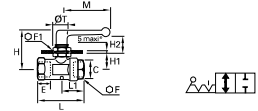

DN	C	Code	E	F	F1	H	H1	H2	L	L1	M	T	Kg
4	G1/8	0446 04 10*	8	14	22	37	14	12	44	25	48	16.5	0.112
7	G1/4	0446 07 13	12	19	24	45	19	14	53	28	48	20.5	0.188
10	G3/8	0446 10 17	12	24	27	50	21	21	59	31	69	20.5	0.294
13	G1/2	0446 13 21	15	27	27	51	23	21	67	34	69	20.5	0.338

Maximum working pressure: 20 bar  
\*For G1/8 version, maximum panel thickness = 3 mm

## 6402 2/2 In-Line Ball Valve for Screw Fixing, Female BSPP Thread

Nickel-plated brass, NBR

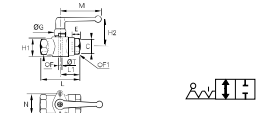

DN	C	Code	E	F	F1	G	H1	H2	L	L1	M	N	T	Kg
4	G1/8	6402 04 10	8	14	14	18	18	30	44	25	48	25	470	0.132
7	G1/4	6402 07 13	12	19	19	19	24	31	53	28	48	31	580	0.216
10	G3/8	6402 10 17	12	24	24	20	30	45	59	31	69	31	580	0.324
13	G1/2	6402 13 21	15	27	27	20	34	47	67	34	69	34	6100	0.404
20	G3/4	6402 20 27	16.5	32	38	27	44	52	80	39	108	43	8125	0.830
23	G1	6402 23 34	19	41	46	27	53	56	94	47	108	51	8125	1.290

Maximum working pressure: 40 bar

## 6401 2/2 In-Line Ball Valve for Screw Fixing, Male/Female BSPP Thread

Nickel-plated brass, NBR

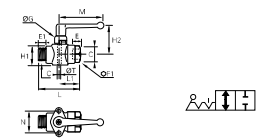

DN	C	Code	E	E1	F	G	H1	H2	L	L1	M	N	T	Kg
4	G1/8	6401 04 10	8	7	14	18	18	30	45	25	48	25	470	0.127
7	G1/4	6401 07 13	12	9	19	19	24	31	52	28	48	31	580	0.212
10	G3/8	6401 10 17	12	11	24	20	30	45	58	31	69	31	580	0.306
13	G1/2	6401 13 21	15	12	27	20	34	47	67	34	69	34	6100	0.394

Maximum working pressure: 40 bar

## 0472 2/2 Right-Angled Ball Valve, Female BSPP Thread

Nickel-plated brass, NBR

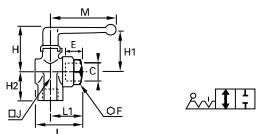

DN	C	Code	E	F	H	H1	H2	J	L	L1	M	Kg
4	G1/8	0472 04 10	8	14	35	29	18	14	34	25	48	0.096
6	G1/4	0472 06 13	12	19	38	31	24	22	38	28	48	0.191
9	G3/8	0472 09 17	12	24	45	43	27	25	46	31	69	0.260
12	G1/2	0472 12 21	15	27	47	44	33	29	49	34	69	0.312
18	G3/4	0472 18 27	16.5	38	59	51	40	39	60	39	108	0.704
23	G1	0472 23 34	19	46	63	55	47	48	72	47	108	1.062

Maximum working pressure: 20 bar

## 0401 2/2 In-Line Ball Valve, Male/Female BSPP Thread

Nickel-plated brass, NBR

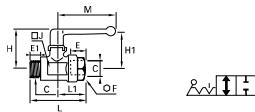

DN	C	Code	E	E1	F	H	H1	J	L	L1	M	Kg
4	G1/8	0401 04 10	8	7	14	35	29	14	45	25	48	0.094
5	G1/8	0401 05 10	8	7	19	38	31	19	51	27	48	0.160
7	G1/4	0401 07 13	12	9	19	38	31	19	52	28	48	0.150
10	G3/8	0401 10 17	12	11	24	45	43	24	58	31	69	0.234
13	G1/2	0401 13 21	15	12	27	47	44	27	66	34	69	0.286
18	G3/4	0401 18 27	16.5	12	38	63	54	39	79	39	108	0.652
23	G1	0401 23 34	19	15	46	67	57	48	91	47	108	0.952
32	G1 1/4	0401 32 42*	21.5	18	60	97	115	55	113	59	108	2.385

\*Models with EC marking  
Maximum working pressure: 40 bar

## 0414 2/2 In-Line Ball Valve with Compression Connections

Nickel-plated brass, NBR

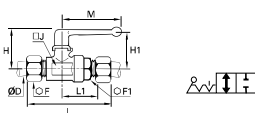

DN	ØD	Code	F	F1	H	H1	J	L	L1	M	Kg
4	6	0414 04 06	13	19	38	31	19	72	31	48	0.177
6	8	0414 06 08	14	19	38	31	19	74	30	48	0.180
7	10	0414 07 10	19	19	38	31	19	78	31	48	0.210
10	12	0414 10 12	22	24	45	43	24	86	36	69	0.308

Maximum working pressure: 40 bar



## 0471 2/2 Right-Angled Ball Valve, Male/Female BSPP Thread

Nickel-plated brass, NBR

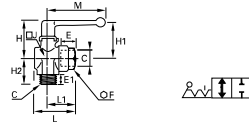

DN	C	E	E1	F	H	H1	H2	J	L	L1	M	Kg
4	G1/8	0471 04 10	8	7	14	35	29	19	14	34	25	0.096
6	G1/8	0471 06 10	8	7	19	38	31	22	22	37	27	0.182
	G1/4	0471 06 13	12	9	19	38	31	25	22	38	28	0.187
9	G3/8	0471 09 17	12	11	24	45	43	28	25	46	31	0.256
12	G1/2	0471 12 21	15	12	27	47	44	32	29	49	34	0.303
18	G3/4	0471 18 27	16.5	12	38	59	51	37	39	60	39	0.682
23	G1	0471 23 34	19	15	46	63	55	44	48	72	47	1.020

Maximum working pressure: 20 bar

## 0482 3/3 Right-Angle Ported Ball Valve, Female BSPP Thread

Nickel-plated brass, NBR

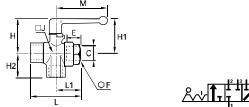

DN	C	E	F	H	H1	H2	J	L	L1	M	Kg
4	G1/8	0482 04 10	8	14	35	29	18	14	44	25	0.102
6	G1/4	0482 06 13	12	19	38	31	24	22	53	28	0.200
9	G3/8	0482 09 17	12	24	45	43	27	25	59	31	0.284
12	G1/2	0482 12 21	15	27	47	44	33	29	67	34	0.346
18	G3/4	0482 18 27	16.5	38	59	51	40	39	80	39	0.742
23	G1	0482 23 34	19	46	63	55	47	48	94	47	1.160

Maximum working pressure: 20 bar

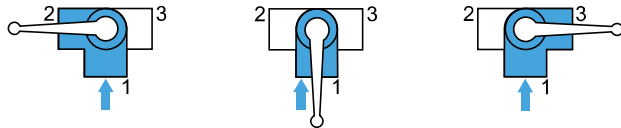

## 0483 3/3 Right-Angle Ported Ball Valve Without Closed Position, Female BSPP Thread

Nickel-plated brass, NBR

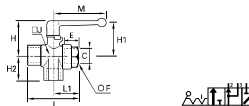

DN	C	E	F	H	H1	H2	J	L	L1	M	Kg
4	G1/8	0483 04 10	8	14	35	29	18	14	44	25	0.102
6	G1/4	0483 06 13	12	19	38	31	24	22	53	28	0.196
9	G3/8	0483 09 17	12	24	45	43	27	25	59	31	0.278
12	G1/2	0483 12 21	15	27	47	44	33	29	67	34	0.340
18	G3/4	0483 18 27	16.5	38	59	51	40	39	80	39	0.716
23	G1	0483 23 34	19	46	63	55	47	48	94	47	1.066

Maximum working pressure: 20 bar

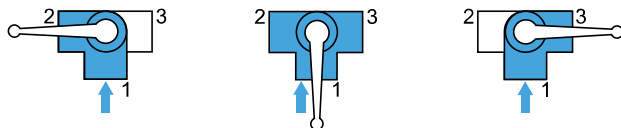

## 0448 3/3 Panel-Mountable Right-Angled Ball Valve, Female BSPP Thread

Nickel-plated brass, NBR

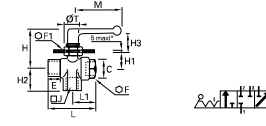

DN	C	E	F	F1	H	H1	H2	H3	J	L	L1	M	T	Kg
4	G1/8	0448 04 10*	8	14	22	37	14	18	12	14	44	25	48	16.5 0.126
6	G1/4	0448 06 13	12	19	24	45	19	24	14	22	53	28	48	20.5 0.230
9	G3/8	0448 09 17	12	24	27	50	21	27	21	25	59	31	69	20.5 0.328
12	G1/2	0448 12 21	15	27	27	51	23	33	21	29	67	34	69	20.5 0.392

Maximum working pressure: 20 bar

\*For G1/8 version: maximum panel thickness = 3 mm

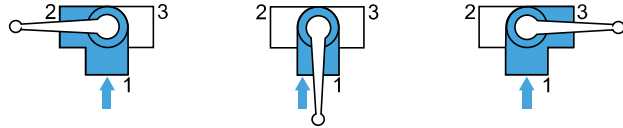

## 0452 3/2 Panel-Mountable Equal Plane Ball Valve, Female BSPP Thread

Nickel-plated brass, NBR

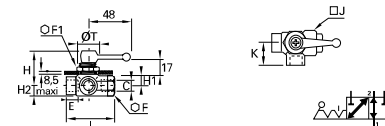

DN	C	E	F	F1	H	H1	H2	J	K	L	T	Kg	
4	G1/8	0452 04 10	8	14	22	39	10	8	16	18	25	19	0.130
6	G1/4	0452 06 13	12	19	24	40	11	11	23	24	28	20	0.206

Maximum working pressure: 20 bar

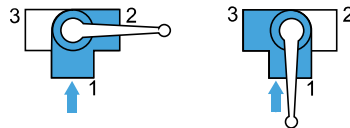

## 0489 3/2 In-Line Threaded Exhaust Port Ball Valve, Female BSPP and Metric Thread

Nickel-plated brass, NBR

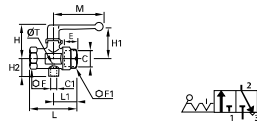

DN	C1	C		E	F	F1	H	H1	H2	L	L1	M	T	Kg
7	M5x0.8	G1/4		0489 07 13	12	24	24	46	43	17	59	31	69	2 0.270
10	M5x0.8	G3/8		0489 10 17	12	24	24	46	43	17	59	31	69	2 0.243
13	G1/8	G1/2		0489 13 21	15	27	27	47	44	24	67	34	69	2 0.310
18	G1/4	G3/4		0489 18 27	16.5	32	38	63	54	33	80	39	108	2.5 0.670
23	G1/4	G1		0489 23 34	19	41	46	67	57	37	94	47	108	3 1.050

Maximum working pressure: 40 bar

## 0462 3/2 Right-Angled Ball Valve with Vent, Female BSPP Thread

Nickel-plated brass, NBR

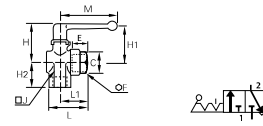

DN	C		E	F	H	H1	H2	J	L	L1	M	Kg
6	G1/8		0462 06 10	8	19	38	31	20	22	37	27	48 0.192
	G1/4		0462 06 13	12	19	38	31	24	22	38	28	48 0.185
9	G3/8		0462 09 17	12	24	45	43	27	25	46	31	69 0.261
12	G1/2		0462 12 21	15	27	47	44	33	29	49	34	69 0.311
18	G3/4		0462 18 27	16.5	38	59	51	40	39	60	39	108 0.698
23	G1		0462 23 34	19	46	63	55	47	48	72	47	108 1.066

Maximum working pressure: 20 bar

## 0449 3/2 Panel-Mountable In-Line Threaded Exhaust Port Ball Valve, Female BSPP and Metric Thread

Nickel-plated brass, NBR

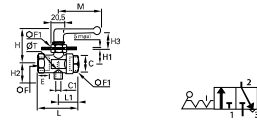

DN	C1	C		E	F	F1	H	H1	H2	H3	L	L1	M	T	Kg
7	M5x0.8	G1/4		0449 07 13	12	24	27	50	20	17	21	59	31	69	2.5 0.313
10	M5x0.8	G3/8		0449 10 17	12	24	27	50	20	17	21	59	31	69	2.5 0.291
13	G1/8	G1/2		0449 13 21	15	27	27	52	23	24	21	67	34	69	4 0.352

Maximum working pressure: 20 bar

## 0461 3/2 Right-Angled Ball Valve with Vent, Male/Female BSPP Thread

Nickel-plated brass, NBR

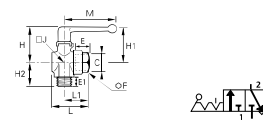

DN	C		E	E1	F	H	H1	H2	J	L	L1	M	Kg
6	G1/8		0461 06 10	8	7	19	38	31	20	22	37	27	48 0.182
	G1/4		0461 06 13	12	9	19	38	31	24	22	38	28	48 0.186
9	G3/8		0461 09 17	12	11	24	45	43	27	25	46	31	69 0.257
12	G1/2		0461 12 21	15	12	27	47	44	33	29	49	34	69 0.304
18	G3/4		0461 18 27	16.5	12	38	59	51	40	39	60	39	108 0.648

Maximum working pressure: 20 bar

## 0469 3/2 In-Line Vented Ball Valve, Female BSPP Thread

Nickel-plated brass, NBR

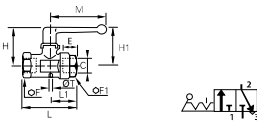

DN	C		E	F	F1	H	H1	L	L1	M	T	Kg
4	G1/8		0469 04 10	8	14	14	35	29	44	25	48	1.5 0.092
7	G1/4		0469 07 13	12	24	24	46	43	59	31	70	2 0.268
10	G3/8		0469 10 17	12	24	24	46	43	59	31	70	2 0.246
13	G1/2		0469 13 21	15	27	27	47	44	67	34	70	2 0.294
18	G3/4		0469 18 27	16.5	32	38	63	54	80	39	108	2.5 0.668
23	G1		0469 23 34	19	41	46	67	57	94	47	108	3 1.026

Maximum working pressure: 40 bar

### Operation of Vented Ball Valves

With vent connected to a tube = collection of purged media

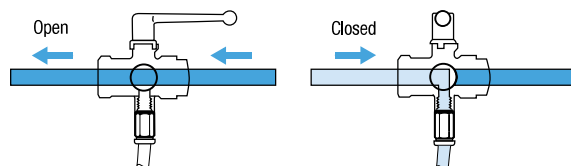

With vent connected to a silencer = noiseless discharge to atmosphere

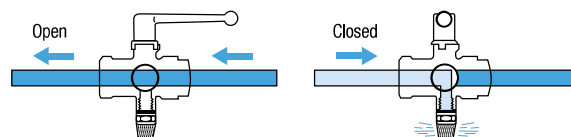

## 0432 2/2 In-Line Lockable Ball Valve, Female BSPP Thread

Nickel-plated brass, NBR

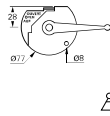
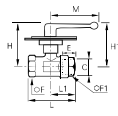

DN	C		E	F	F1	H	H1	L	L1	M	Kg
4	G1/8	0432 04 10	8	19	19	59	54	51	27	69	0.415
7	G1/4	0432 07 13	12	19	19	59	54	59	28	69	0.396
10	G3/8	0432 10 17	12	24	24	60	55	59	31	69	0.460
13	G1/2	0432 13 21	15	27	27	62	57	67	34	69	0.510
20	G3/4	0432 20 27	16.5	32	38	66	56	80	39	108	0.800
23	G1	0432 23 34	19	41	46	70	59	94	47	108	1.186

Maximum working pressure: 40 bar  
Handle is not removable.  
Fixed and mobile plates: zinc-plated steel.

## 0437 3/2 In-line Vented 3-Point Lockable Ball Valve, Female BSPP Thread

Nickel-plated brass, NBR

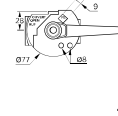
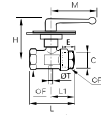

DN	C		E	F	F1	H	L	L1	M	T	Kg
7	G1/4	0437 07 13	12	24	24	60	59	32	69.5	2	0.476
10	G3/8	0437 10 17	12	24	24	60	60	32	69.5	2	0.447
13	G1/2	0437 13 21	15	27	27	60	67.5	34.5	69.5	2	0.510
18	G3/4	0437 18 27	16.5	32	38	69.5	80	39.5	108.5	2.5	0.820
23	G1	0437 23 34	19	41	46	73	94.5	47.5	108.5	3	1.192

Maximum working pressure: 40 bar  
Handle is not removable  
Locking plates are zinc-plated steel

## 0439 3/2 In-line Vented Lockable Ball Valve, Female BSPP Thread

Nickel-plated brass, NBR

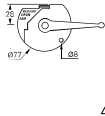
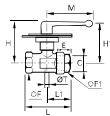

DN	C		E	F	F1	H	H1	L	L1	M	T	Kg
4	G1/8	0439 04 10	8	19	19	59	54	51	27	69	2	0.410
7	G1/4	0439 07 13	12	24	24	60	55	59	31	69	2	0.480
10	G3/8	0439 10 17	12	24	24	60	55	59	31	69	2	0.460
13	G1/2	0439 13 21	15	27	27	62	57	67	34	69	2	0.514
18	G3/4	0439 18 27	16.5	32	38	66	56	80	39	108	2.5	0.810
23	G1	0439 23 34	19	41	46	70	59	94	47	108	3	1.185

Maximum working pressure: 40 bar  
Handle is not removable, locking plates are zinc-plated steel.

## 0438 3/2 Right-Angled 3-Point Lockable Ball Valve, Female BSPP Thread

Nickel-plated brass, NBR

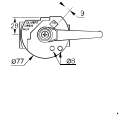
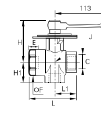

DN	C		E	F	H	H1	J	L	L1	Kg
9	G3/8	0438 09 17	12	38	76	34	39	73	35	0.970
12	G1/2	0438 12 21	15	38	76	37	39	78	38	0.947
18	G3/4	0438 18 27	16.5	38	76	40	39	80	40	0.905
23	G1	0438 23 34	19	46	80	47	48	94	47	1.295

Maximum working pressure: 20 bar  
Fixed plate: zinc-plated steel, mobile plate: zinc-plated steel  
Removable handle: where the handle is obstructed in its movement, it can be refitted opposite the original position.

## 0436 3/2 In-Line 3-Point Lockable Ball Valve with Threaded Exhaust Port, Female BSPP and Metric Thread

Nickel-plated brass, NBR

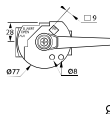
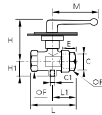

DN	C1	C		E	F	F1	H	H1	L	L1	M	Kg
10	M5x0.8	G3/8	0436 10 17	12	24	24	60	17	60	32	69	0.475
13	G1/8	G1/2	0436 13 21	15	27	27	60	24.5	67.5	34.5	69	0.500
18	G1/4	G3/4	0436 18 27	16.5	32	38	69.5	33	80	39.5	108	0.850
23	G1/4	G1	0436 23 34	19	41	46	73.5	47.5	94.5	47.5	108.5	1.215

Maximum working pressure: 40 bar  
Handle is not removable.  
Fixed and mobile plates: zinc-plated steel

# Universal Light Series



Suitable for small, compact and resistant spaces, these ball valves are easy to operate.

## Technical Characteristics

- **Compatible Fluids:** Industrial fluids
- **Working Pressure:** Vacuum to 12 bar
- **Working Temperature:** -20°C to +80°C

Reliable performance is dependent upon the type of fluid conveyed, component materials and tubing being used.

Guaranteed for use with a vacuum of 755 mm Hg (99% vacuum).

## Advantages

- Compactness
- Corrosion resistance due to chemical nickel plating
- Automatic compensation of seal wear
- Repositionable and exchangeable handles

## Regulations

- PED
- REACH
- RoHS

## Component Materials

### Silicone-free

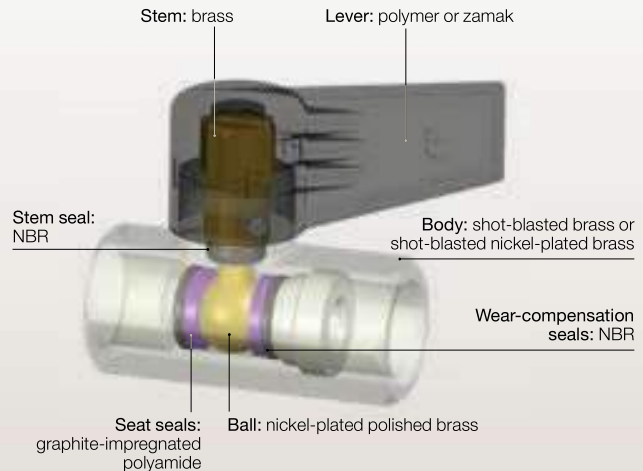

## 0492 2/2 In-Line Ball Valve, Female BSPP Thread

Nickel-plated brass, NBR

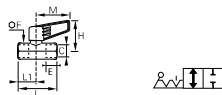

DN	C		E	F	H	L	L1	M	Kg
4	G1/4	0492 04 13	9	17	34	39.5	17	35	0.073
7	G3/8	0492 07 17	11	22	38	45	20	43	0.128
10	G1/2	0492 10 21	12	24	44	54	25	50	0.150
13	G3/4	0492 13 27	14	30	46	62	28	50	0.240

Technical polymer handle

## 0491 2/2 In-Line Ball Valve, Male/Female BSPP Thread

Nickel-plated brass, NBR



DN	C		E	E1	F	H	L	L1	M	Kg
4	G1/4	0491 04 13	9	7	17	34	39.5	17	35	0.070
7	G3/8	0491 07 17	11	8	22	38	45	20	43	0.124
10	G1/2	0491 10 21	12	10	24	44	53	24	50	0.160
13	G3/4	0491 13 27	14	12	30	46	59	25	50	0.238

Technical polymer handle

## 0492..64 2/2 In-Line Ball Valve, Short Handle, Female BSPP Thread

Nickel-plated brass, NBR



DN	C		E	F	H	L	L1	M	Kg
4	G1/4	0492 04 13 64	9	17	36	39.5	17	25	0.090

Short handle in zamak

## 0491..64 2/2 In-Line Ball Valve, Short Handle, Male/Female BSPP Thread

Nickel-plated brass, NBR

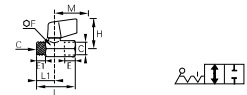

DN	C		E	E1	F	H	L	L1	M	Kg
4	G1/4	0491 04 13 64	9	7	17	36	39.5	17	25	0.092

Short handle in zamak

## 0490 2/2 In-Line Ball Valve, Male BSPP Thread

Nickel-plated brass, NBR

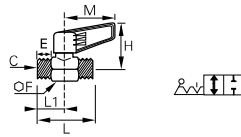

DN	C		E	F	H	L	L1	M	Kg
4	G1/4	0490 04 13	7	17	34	39	17	35	0.070
7	G3/8	0490 07 17	8	22	38	44	20	43	0.109
10	G1/2	0490 10 21	10	24	44	53	24	50	0.160
13	G3/4	0490 13 27	12	30	46	59	25	50	0.233

Technical polymer handle

## 0497 2/2 Ball Valve, Square Stem, Female BSPP Thread

Brass, NBR

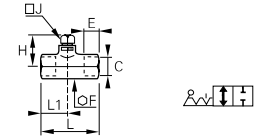

DN	C		E	F	H	J	L	L1	Kg
4	G1/4	0497 04 13	9	17	25	7	39	17	0.063
7	G3/8	0497 07 17	11	22	26	7	45	20	0.122
10	G1/2	0497 10 21	12	24	29	10	54	25	0.141
13	G3/4	0497 13 27	14	30	30	10	62	28	0.230

## 0494 2/2 In-Line Ball Valve, 2 Vent Plugs, Female BSPP Thread

Nickel-plated brass, NBR

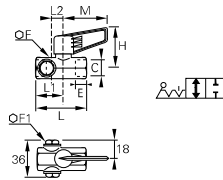

DN	C		E	F	F1	H	L	L1	L2	M	Kg
7	G3/8	0494 07 17	11	22	16	38	60	20	15	43	0.178

Technical polymer handle

## 0496 2/2 Ball Valve, Square Stem, Male/Female BSPP Thread

Brass, NBR

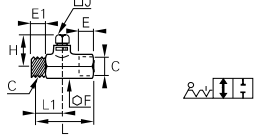

DN	C		E	E1	F	H	J	L	L1	Kg
4	G1/4	0496 04 13	7	9	17	25	7	39	17	0.065
7	G3/8	0496 07 17	8	11	22	26	7	45	20	0.118
10	G1/2	0496 10 21	10	12	24	29	10	53	24	0.150
13	G3/4	0496 13 27	12	14	30	30	10	59	28	0.222



Compliant with DVGW certification, standardized threads, these valves ensure the transport of gas and water.

## Technical Characteristics

- **Compatible Fluids:** Compressed air, water, gas
- **Working Pressure:** 1/4" to 2": 0 to 40 bar
- **Working Temperature:** -50°C to +170°C

Reliable performance is dependent upon the type of fluid conveyed. Products have been tested at -50°C in static sealing and after 5 operations for a leak rate < 0,05NI/h.

## Advantages

- Stem prevented from being ejected in the event of overpressure
- Two stem seal to prevent leakage
- Corrosion resistance, increased chemical compatibility thanks to chemical nickel plating
- Can be operated at very low temperatures: -50°C

## Component Materials

### Silicone-free

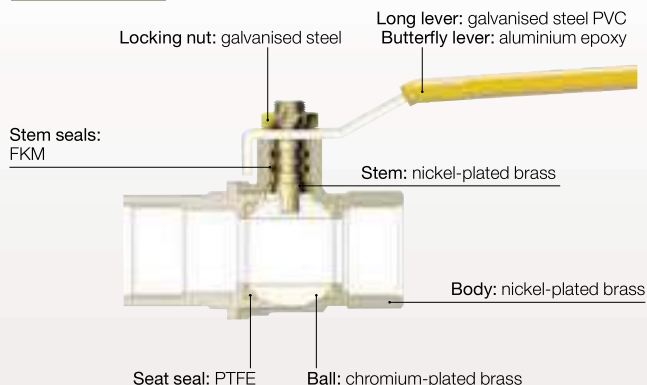

## Working Pressure and Temperature

Pressure - Temperature

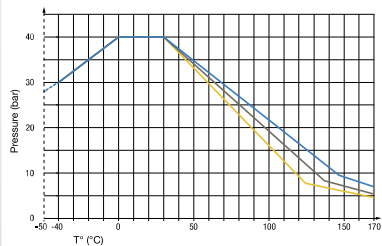

Pressure Drop

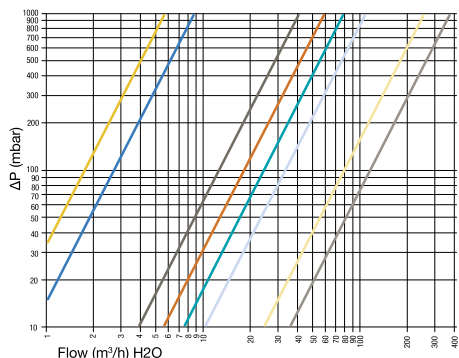

## Regulations

**Industrial**  
**DI: 97/23/EC**  
**(PED B+D module EC 1115)**  
**Water**  
**DVGW: W 570-1**  
**DIN EN 13228**  
**BGA KTW**  
**DVGW: W270**  
**Gas**  
**DIN EN 33**

## BVG4-L 2/2 In-Line Ball Valve, Female BSPP Thread

Nickel-plated brass

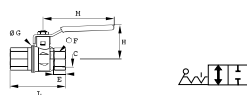

DN	C		E	F	G	H	L	M	Kg
8	G1/4	BVG4-1/4L	12	20	25	38	50	82	0.150
10	G3/8	BVG4-3/8L	12	20	25	38	60	82	0.161
15	G1/2	BVG4-1/2L	15.5	25	32.5	43	75	100	0.256
20	G3/4	BVG4-3/4L	17	32	39	50	80	120	0.397
25	G1	BVG4-1L	21	41	47.5	54	90	120	0.641
32	G1 1/4	BVG4-1.1/4L	23	50	59	73	110	158	0.980
40	G1 1/2	BVG4-1.1/2L	23	55	71.5	79	120	158	1.205
50	G2	BVG4-2L	26.5	70	86	86	140	158	1.960

## BVGT4-L 2/2 In-Line Ball Valve, Female BSPP Thread, Butterfly Handle

Nickel-plated brass

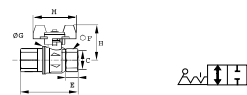

DN	C		E	F	G	H	L	M	Kg
8	G1/4	BVGT4-1/4L	12	20	25	39	50	50	0.137
10	G3/8	BVGT4-3/8L	12	20	25	39	60	50	0.129
15	G1/2	BVGT4-1/2L	15.5	25	32.5	43	75	50	0.231
20	G3/4	BVGT4-3/4L	17	32	39	47	80	60	0.348
25	G1	BVGT4-1L	21	41	47.5	51	90	60	0.546

Compact lever

# Standard Series



For common industrial applications, these ball valves are equipped with fluoropolymer seals and a lockable system.

## Technical Characteristics

Model	Standard and Lockable Series	Compact Series
Compatible Fluids	Compressed air Other fluids : see compatibility chart at the end of this chapter	
Working Pressure	0 to 40 bar up to 2" 0 to 30 bars over 2" excepted BVG4P-LOCK: 0 to 14 bar	0 to 30 bar
Working Temperature	-20°C to +170°C Excepted BVG4P-LOCK: -10°C to +100°C	-10°C to +90°C

Reliable performance is dependent upon the type of fluid conveyed.

## Advantages

- Long or butterfly handle
- Full fluid flow
- A lockable version for safety in use
- Corrosion resistance thanks to chemical nickel plating

## Component Materials

Silicone-free

Long lever: Geomet® plated steel  
Compact Series lever: technical polymer  
Butterfly lever: Aluminium

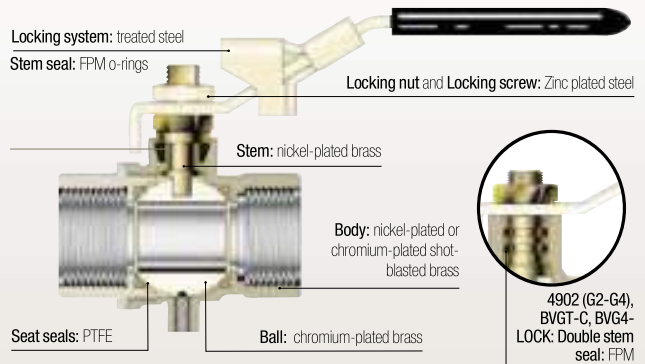

## Regulations

Industrial:

- PED
- REACH
- RoHS

## 4902 2/2 Standard In-Line Ball Valve, Female BSP Thread

Nickel-plated brass, PTFE

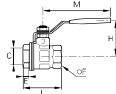

DN	C		E	F	H	L	M	PN	Kg
8	G1/4	4902 10 13	9	20	38	39	82	40	0.131
10	G3/8	4902 10 17	9	20	38	39	82	40	0.117
15	G1/2	4902 15 21	11	25	43	50	100	40	0.204
20	G3/4	4902 20 27	12	31	50	54	120	40	0.329
25	G1	4902 25 34	14	38	54	67	120	40	0.468
32	G1 1/4	4902 32 42*	15	48	73	77	158	30	0.770
40	G1 1/2	4902 40 49*	17	54	79	90	158	30	1.040
50	G2	4902 50 48*	19	66	86	106	158	30	1.760
65	G2 1/2	4902 65 47*	22	85	132	136	255	30	4.500
80	G3	4902 80 46*	25	99	140	157	255	30	5.840
100	G4	4902 01 45*	29	125	154	191	255	30	9.040

\*Models with EC marking  
Model from 2 1/2": double stem seal in FPM  
Working temperature: -20°C to +170°C

## 4991 2/2 Standard Compact In-Line Ball Valve, Male/Female BSP Thread

Chromium brass, PTFE



DN	C		E	E1	F	H	L	L1	M	Kg
6	G1/8	4991 00 10	10	10	21	30	41.5	10	24	0.089
8	G1/4	4991 00 13	11	11	21	30	41.5	11	24	0.082
	G3/8	4991 00 17	11	11	21	30	41.5	10.5	24	0.087
10	G1/2	4991 00 21	13	13	25	32	49	12.5	24	0.134

## 4992 2/2 Standard Compact In-Line Ball Valve, Female BSP Thread

Chromium brass, PTFE

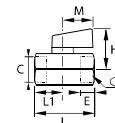

DN	C		E	F	H	L	L1	M	Kg
6	G1/8	4992 00 10	10	21	30	41.5	10	24	0.111
8	G1/4	4992 00 13	11	21	30	41.5	11	24	0.100
	G3/8	4992 00 17	11	21	30	41.5	10.5	24	0.094
10	G1/2	4992 00 21	13	25	32	49	12.5	24	0.142

## BVGT4-C 2/2 Standard In-Line Ball Valve, Female BSPP Thread, Butterfly Handle

Nickel-plated brass

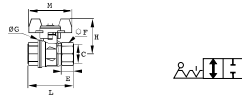

DN	C		E	F	G	H	L	M	Kg
8	G1/4	<b>BVGT4-1/4C</b>	9	20	25	40	39	50	0.130
10	G3/8	<b>BVGT4-3/8C</b>	9	20	25	40	39	50	0.120
15	G1/2	<b>BVGT4-1/2C</b>	11	25	32.5	44	50	50	0.180
20	G3/4	<b>BVGT4-3/4C</b>	12	31	39	49	54	50	0.265
25	G1	<b>BVGT4-1C</b>	14	38	47.5	53	67	50	0.390

Compact leverDouble stem seal in FPM  
Working temperature: -40°C to +170°C

## BVG4-LOCK 2/2 In-Line Lockable Ball Valve, Female BSPP Thread

Nickel-plated brass

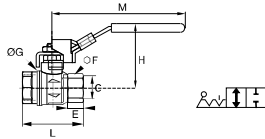

DN	C		E	F	H	L	M	Kg
8	G1/4	<b>BVG4-1/4LOCK</b>	9	20	46	39	96	0.150
10	G3/8	<b>BVG4-3/8LOCK</b>	9	20	46	39	96	0.150
15	G1/2	<b>BVG4-1/2LOCK</b>	11	25	51	50	96	0.255
19	G3/4	<b>BVG4-3/4LOCK</b>	12	31	59	54	117	0.390
25	G1	<b>BVG4-1LOCK</b>	14	38	63	67	117	0.590

## BVG4P-LOCK 3/2 In-Line Lockable Vented Ball Valve, Female BSPP Thread

Nickel-plated brass

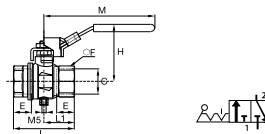

DN	C		E	F	H	L	L1	M	Kg
8	G1/4	<b>BVG4P-1/4LOCK</b>	12	20	47.5	45	22.5	96	0.155
10	G3/8	<b>BVG4P-3/8LOCK</b>	12	20	47.5	45	22.5	96	0.172
15	G1/2	<b>BVG4P-1/2LOCK</b>	15.5	25	52	59	29.5	96	0.239
20	G3/4	<b>BVG4P-3/4LOCK</b>	17	31	59.5	64	32	117	0.371
25	G1	<b>BVG4P-1LOCK</b>	21	40	63.5	81	40.5	117	0.581



# Stainless Steel Series



For severe food or industrial process applications, a series with a 316L stainless steel body that withstands aggressive environments, as well as high pressures and temperatures.

## Technical Characteristics

Compatible Fluids	Types 4810, 4812 and 4832	Type 0465
	All fluids	All fluids
Working Pressure	0 to 65 bar	Vacuum to 20 bar
Working Temperature	-20°C to +150°C	-20°C to +120°C

Reliable performance is dependent upon the type of fluid conveyed, component materials and tubing being used.

Guaranteed for use with a vacuum of 755 mm Hg (99% vacuum).

## Advantages

- Chemical compatibility
- High temperature operation: up to +150°C
- 3 straight versions :
  - Compact type cannot be disassembled
  - 3-piece can be disassembled
  - Light series for more compactness

## Component Materials

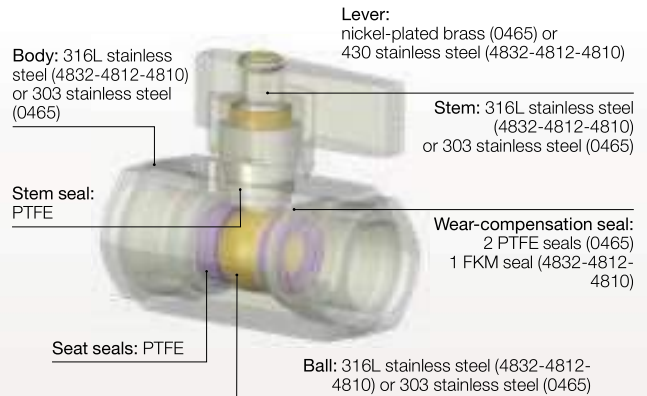

## Regulations

Industrial:

- PED
- RoHS

- REACH

## Pressure and Temperature Resistance

### Version 4810, 4812 and 4832

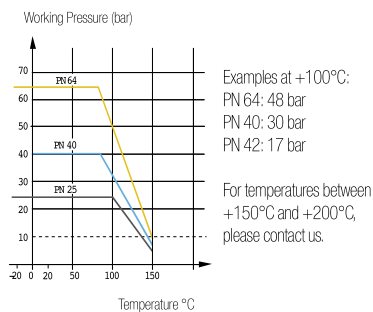

### Version 0465

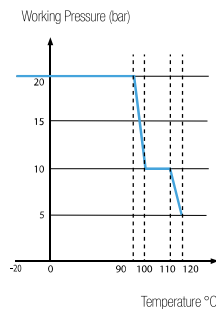

## 4832 2/2 In-Line 3-Piece Ball Valve with Fixing Plate, Female BSPP Thread

Stainless steel 316L, PTFE

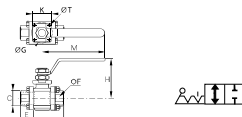

DN	C	E	F	G	H	K	L	M	T	Kg
10	G1/4 4832 10 13**	18	22	36	50	36	57	110.5	5.5	0.272
15	G1/2 4832 15 21	20.5	27	36	64	36	65	131.5	6	0.478
20	G3/4 4832 20 27	22.5	32	42	68	42	76	131.5	5.5	0.568
25	G1 4832 25 34	27	41	42	78.5	42	92	174.5	6	1.229
32	G1 1/4 4832 32 42*	30	50	42	83.5	42	106.5	174.5	5.5	1.530
40	G1 1/2 4832 40 49*	31	55	50	100	50	116	250.5	6.5	2.146
50	G2 4832 50 48*	36	70	50	107	50	136	250.5	6.5	3.140

\*Models with EC marking  
\*\* Without Fixing Plate

## 4812 2/2 In-Line Ball Valve with Fixing Plate, Female BSPP Thread

Stainless steel 316L, PTFE

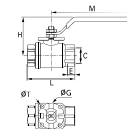

DN	C	E	G	H	L	M	T	Kg
10	G1/4 4812 10 13	10	36	50	55	110	5.5	0.263
	G3/8 4812 10 17	11	36	50	55	110	5.5	0.254
15	G1/2 4812 15 21	15	36	53	66	110	5.5	0.336
20	G3/4 4812 20 27	16	42	67	79	130	5.5	0.574
25	G1 4812 25 34	19	42	79	93	175	5.5	1.010
32	G1 1/4 4812 32 42*	21	42	83	100	175	5.5	1.337
40	G1 1/2 4812 40 49*	21	50	100	110	250	5.5	2.161
50	G2 4812 50 48*	26	70	107	131	250	8.5	3.262

\*Models with EC marking

## 4810 2/2 In-Line Ball Valve, Female BSPP Thread

Stainless steel 316L, PTFE

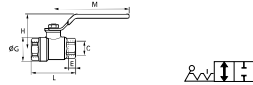

DN	C		E	G	H	L	M	Kg
8	G1/4	<b>4810 08 13</b>	10	30	44,5	53,5	110,5	0.206
10	G3/8	<b>4810 10 17</b>	10	30	44,5	53,5	110,5	0.190
15	G1/2	<b>4810 15 21</b>	13	32,5	47	60	110,5	0.245
20	G3/4	<b>4810 20 27</b>	14	40	54,5	70	131,5	0.418
25	G1	<b>4810 25 34</b>	17	49	58,5	79	131,5	0.648

## 0465 2/2 In-Line Light Series Ball Valve, Female BSPP Thread

Stainless steel 303, PTFE

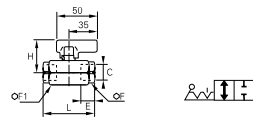

DN	C		E	F	F1	H	L	Kg
4	G1/4	<b>0465 04 13</b>	13	19	24	36	50	0.226
7	G3/8	<b>0465 07 17</b>	13	24	27	39	55	0.278
10	G1/2	<b>0465 10 21</b>	16	27	30	40	62	0.322

Silicone-free

# High Pressure Series



Designed for applications up to 300 bar, these carefully manufactured ball valves guarantee safe operation.

## Technical Characteristics

- **Compatible Fluids:** Compressed air, lubricants, gases
- **Working Pressure:** Vacuum to 300 bar
- **Working Temperature:** -15°C to +80°C

Reliable performance is dependent upon the type of fluid conveyed, component materials and tubing being used.

Guaranteed for use with a vacuum of 755 mm Hg (99% vacuum).

## Advantages

- Low operating torque, even at high pressure
- Repositionable and exchangeable handles
- Robust design resistant to high tightening torques
- Fixing screws for through-bulkhead mounting

## Component Materials

### Silicone-free

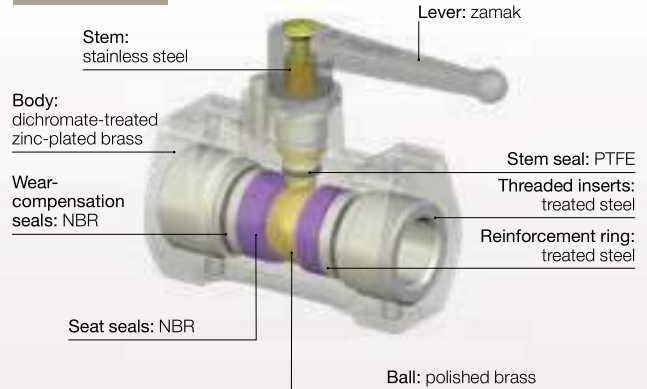

## Regulations

- PED
- REACH
- RoHS

## Installation Options

### Bulkhead Mounting

Through bulkhead with screws

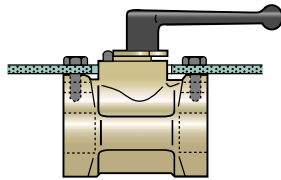

### Surface Mounting

With brackets and screws

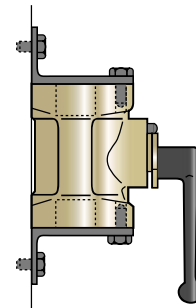

## 4402 2/2 In-Line High Pressure Ball Valve, Female BSPP Thread

Treated brass, NBR

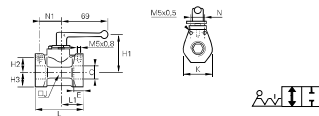

DN	C	E	H1	H2	H3	J	K	L	L1	N	N1	Kg
7	G1/4	4402 07 13	12	50	13	15	30	30	58	25	15	0.402
10	G3/8	4402 10 17	12	54	23	19	36	39	72	36	20	0.722
13	G1/2	4402 13 21	15	56	23	21	40	42	79	36	20	0.870

# Mini Series



Equipped with push-in connections and a technical polymer body, this series combines lightness on the equipment, speed of installation.

## Technical Characteristics

- **Compatible Fluids:** Compressed air, neutral gases
- **Working Pressure:** Vacuum to 10 bar
- **Working Temperature:** -20°C to +80°C

Tightening Torques	Threads	G1/8	G1/4	G3/8	G1/2
	daN.m	0.8	1.2	3	3.5

Reliable performance is dependent upon the type of fluid conveyed, component materials and tubing being used.

Guaranteed for use with a vacuum of 755 mm Hg (99 % vacuum).

## Advantages

- Lightweight and compact
- LF 3000® push-in connections, static and dynamic sealing
- Automatic seal wear compensation for long-term reliability
- Ultra-compact handle, easy operation, screwdriver slot for difficult access

## Installation Options

### Vented Valve, Open Position

3/2 model with vent

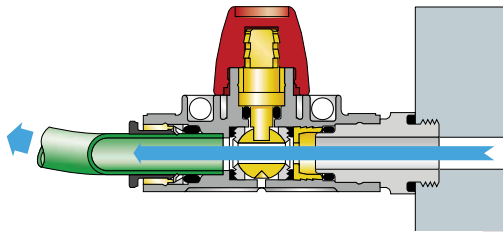

### Vented Valve, Closed Position

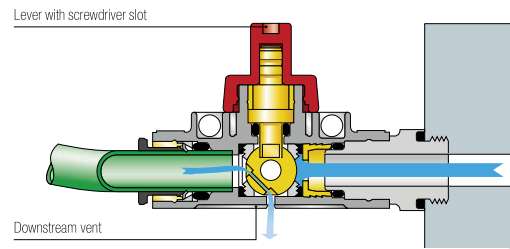

## Component Materials

### Silicone-free



## 7910 2/2 In-Line Mini-Ball Valve

Technical polymer, NBR

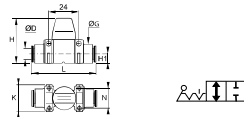

ØD		G	H	H1	K	L	N	Kg
4	7910 04 00	15	37	7.5	22	51	16	0.039
6	7910 06 00	15	37	7.5	22	52	16	0.034
8	7910 08 00	15	37	7.5	22	52	16	0.025
10	7910 10 00	20	43	11	30	66	22	0.060
12	7910 12 00	20	43	11	30	66	22	0.040

## 7911 2/2 In-Line Mini-Ball Valve, Male BSPP Thread

Technical polymer, Nickel-plated brass, NBR

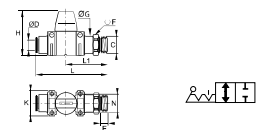

ØD	C		E	F	G	H	K	L	L1	N	Kg
6	G1/8	7911 06 10	5	13	14	37	22	62	37	16	0.045
8	G1/4	7911 08 13	5.5	16	17.5	37	22	61	35	16	0.040
10	G3/8	7911 10 17	5.5	20	22	43	30	74	41	22	0.075
12	G1/2	7911 12 21	7.5	24	26	43	30	75	42	22	0.075

## 7913 3/2 In-Line Mini-Ball Valve with Vent

Technical polymer, NBR

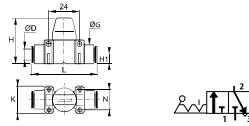

ØD		G	H	H1	K	L	N	Kg
4	7913 04 00	15	37	7.5	22	51	16	0.040
6	7913 06 00	15	37	7.5	22	52	16	0.035
8	7913 08 00	15	37	7.5	22	52	16	0.025
10	7913 10 00	20	43	11	30	66	22	0.060
12	7913 12 00	20	43	11	30	66	22	0.045

## 7914 3/2 In-Line Mini-Ball Valve with Vent, Male BSP Thread

Technical polymer, Nickel-plated brass, NBR

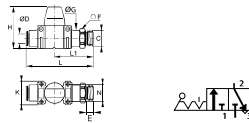

ØD	C	E	F	G	H	K	L	L1	N	Kg	
6	G1/8	7914 06 10	5	13	14	37	22	62	37	16	0.045
8	G1/4	7914 08 13	5.5	16	17.5	37	22	61	35	16	0.040
10	G3/8	7914 10 17	5.5	20	22	43	30	74	41	22	0.058
12	G1/2	7914 12 21	7.5	24	26	43	30	75	42	22	0.075

## 7000 Joining Clips

Technical polymer



ØD		Kg
4	7000 00 04	0.001
6-8	7000 00 05	0.005
10-12	7000 00 06	0.001

## Complementary Products for Mini Series

LF 3000®



PA Tubing



PU Tubing



Flow Regulators





As an integral part of the LIQUIfit® range, these ball valves are designed for water and beverage handling circuits. FDA, NSF and WQA standards are a guarantee of safety for the health of consumers. These ball valves offer sealing and cleanliness to the equipment.

## Technical Characteristics

- **Compatible Fluids:** Water, drinks, beverages, industrial water, CO<sub>2</sub>, inert gases
- **Working Pressure:** 0 to 10 bar at 20°C
- **Working Temperature:** -15°C to +100°C

## Advantages

- Technical polymer body
- Full flow self-sealing ball maintains the cleanliness of the circuit
- LIQUIfit® push-in connection, static and dynamic sealing. No pumping effect. Resistant to water hammer.

## Regulations

- **FDA: 21 CFR**
- **NSF 51**

## Component Materials

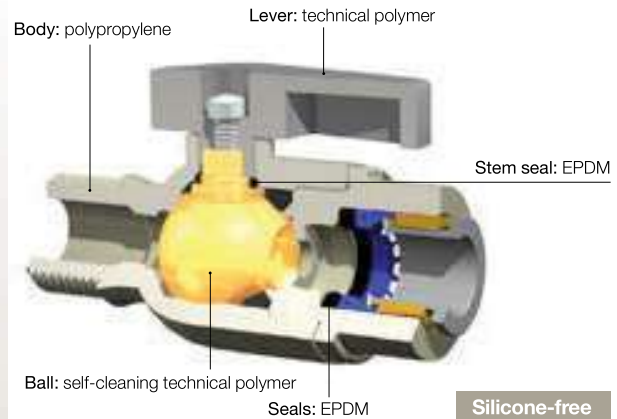

## 4020 In-Line Ball Valve

Polypropylene with fibreglass, EPDM

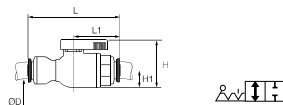

ØD	C	H	H1	L	L1	Kg
6	4020 06 00WP2	36	13	57	27	0.019
8	4020 08 00WP2	36	13	60	27	0.020
10	4020 10 00WP2	36	13	70	33	0.023
12	4020 12 00WP2	36.5	13	88	43	0.034

## 4020 2/2 In-Line Ball Valve

Inch

Polypropylene with fibreglass, EPDM

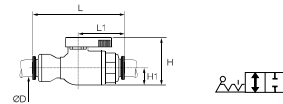

ØD	C	H	H1	L	L1	Kg
1/4	4020 56 00WP2	36	13	57	27	0.015
3/8	4020 60 00WP2	36	13	70	33	0.028

## 4021 2/2 In-Line Ball Valve, Male NPTF Thread

Inch

Polypropylene with fibreglass, EPDM

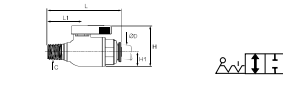

ØD	C	H	H1	L	L1	Kg
1/4	NPTF1/4 4021 56 14WP2	36	13	61	31	0.029
3/8	NPTF3/8 4021 60 18WP2	36	13	64	33.5	0.028

## 4023 2/2 In-Line Ball Valve, Female NPTF Thread

Inch

Polypropylene with fibreglass, EPDM

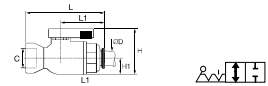

ØD	C	H	H1	L	L1	Kg
3/8	NPTF3/8 4023 60 18WP2	36	13	64	33.5	0.028

## 4022 2/2 Right-Angled Ball Valve, Female NPTF Thread

Inch

Polypropylene with fibreglass, EPDM

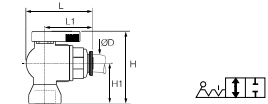

ØD	C	H	H1	L	L1	Kg
1/4	NPTF1/4 4022 56 14WP2	52	29	44	31	0.016

## 4024 2/2 Right-Angled Ball Valve

Polypropylene with fibreglass, EPDM

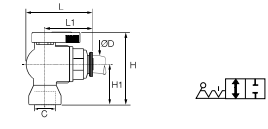

ØD	C	H	H1	L	L1	Kg
6	4024 06 00WP2	54	31	41	27	0.020
10	4024 10 00WP2	61	38	47	33	0.024

# Needle Valves



Made of nickel-plated brass or stainless steel, the needle valves are designed for applications that require manual flow adjustment.

## Technical Characteristics

	Brass	Stainless Steel
Compatible Fluids	Compressed air, water, industrial fluids, etc. Other fluids: contact us	Many fluids
Working Pressure	0 to 120 bar	0 to 400 bar
Working Temperature	-20°C to +100°C (except model 0510)	-20°C to +180°C

Reliable performance is dependent upon the type of fluid conveyed.

## Advantages

- Manual flow adjustment
- Numerous valve and safety accessory configurations

## Component Materials

### Silicone-free

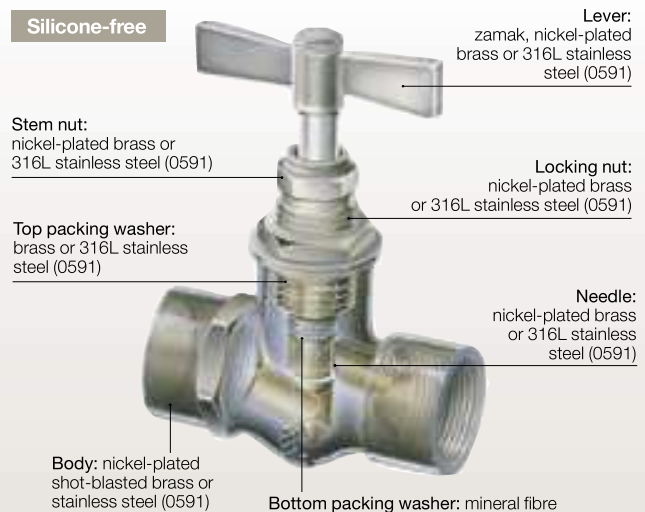

## Regulations

- PED
- REACH
- RoHS

## 0502 In-Line Needle Valve, Female BSPP Thread

Nickel-plated brass

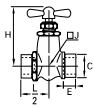

DN	C		E	H	H max	J	L/2	Kg
4	G1/8	0502 04 10	9	56	50	17	23	0.133
	G1/4	0502 04 13	11	56	50	17	23	0.120
6	G3/8	0502 06 17	12	67	60	26	0.171	
9	G3/8	0502 09 17	12	82	70	33	0.426	

## 0510 In-Line Needle Valve with Compression Connections

Nickel-plated brass

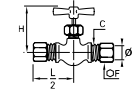

DN	ØD	C		F	H min	H max	L/2	Kg
4	6	M10x1	0510 04 06	13	42	46	29	0.083
8	8	M12x1	0510 05 08	14	42	46	30	0.083
5	10	M16x1.5	0510 05 10	19	42	46	31	0.134

The needle is sealed by an O-ring.

Maximum operating pressure: Ø4: 100 bar, Ø5: 60 bar

Working temperature: -15°C to +70°C

Tightening torques: please refer to the Compression Fittings chapter of this catalogue.

## 0501 In-Line Needle Valve, Male/Female BSPP Thread

Nickel-plated brass

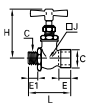

DN	C		E	E1	H	H max	J	L	Kg
4	G1/8	0501 04 10	9	7	56	50	17	44	0.118
	G1/4	0501 04 13	11	9.5	56	50	17	46	0.115
6	G3/8	0501 06 17	12	9.5	67	60	48	0.158	

## 0532 Right-Angle Needle Valve, Female BSPP Thread

Nickel-plated brass

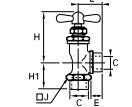

DN	C		E	H min	H max	H1	J	L	Kg
4	G1/8	0532 04 10	9	46	52	46	19	19	0.093
	G1/4	0532 04 13	11	46	52	46	21	21	0.087
6	G1/4	0532 06 13	11	55	63	55	26	22	0.171

## 0531 Right-Angle Needle Valve, Male/Female BSPP Thread

Nickel-plated brass

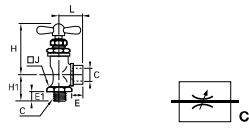

DN	C	E	E1	H min	H max	H1	J	L	Kg	
4	G1/8 0531 04 10	7	9	46	52	46	19	17	19	0.082
	G1/4 0531 04 13	9.5	11	46	52	46	21	17	21	0.090
6	G1/4 0531 06 13	9.5	11	55	63	55	25	22	26	0.155
	G3/8 0531 06 17	9.5	12	55	63	55	25	22	27	0.153
10	G1/2 0531 10 21	13	16	62	72	62	34	26	33	0.329

## 0562 Needle Drain Valve, Male BSPP and Metric Thread

Brass



DN	C	E	F	H min	H max	Kg
5	G1/8 0562 05 10	8	16	36	40	0.032
	G1/4 0562 05 13	10	19	38.5	42.5	0.040
	M10x1 0562 05 60	8	16	37.5	40	0.031

## 0563 Needle Drain Valve, BSPT Thread

Brass



DN	C	F	H min	H max	Kg
5	R1/4 0563 05 14	14	28.5	32.5	0.021

## 0627 Automatic Vent Pressure Gauge Valve, Female BSPP Thread

Nickel-plated brass, NBR

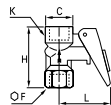

C	F	H	K	L	Kg
G1/4 0627 00 13	19	43.5	20	40	0.097

Pressure: 10 bar

This isolating valve is used to connect a pressure gauge to a circuit.

Resetting the lever isolates and vents the gauge.

A locking pin can be used to enable the gauge to be fitted permanently.

## 0630 Pressure Relief Valve, Male BSPP Thread

Brass

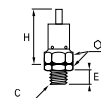

C	E	F	H	Kg
G1/4 0630 06 13	9	17	42.5	0.050

This valve is delivered without calibration, but can be adjusted by inserting metal washers into the hexagon (F).

Maximum working pressure: 10 bar  
Calibration from 1 to 10 bar (not below)

## 0591 Needle Valve, Female BSPP Thread

Stainless steel 316L, PTFE

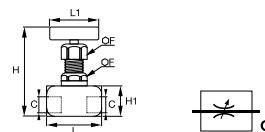

DN	C	F	H min	H max	H1	L	L1	Kg	
3	G1/8 0591 03 10	22	90	99	90	25	45	48	0.342
4	G1/4 0591 04 13	22	90	99	90	25	50	48	0.354
5	G3/8 0591 05 17	22	90	104	90	30	56	48	0.430
6	G1/2 0591 06 21	22	90	104	90	30	62	48	0.478



# Butterfly Valves



The butterfly valve allows frequent operation with very low torque on circuits without retention zones.

## Technical Characteristics

- **Compatible Fluids:** Compressed air, abrasive fluids
- **Working Pressure:** 0 to 16 bar
- **Working Temperature:** -20°C to +80°C

Reliable performance is dependent upon the type of fluid conveyed.

## Advantages

- Compatible with abrasive fluids (including solid particles)
- Fluid flow direction marked (uni-directional)
- Small size
- Simple and efficient design

## Component Materials

### Silicone-free

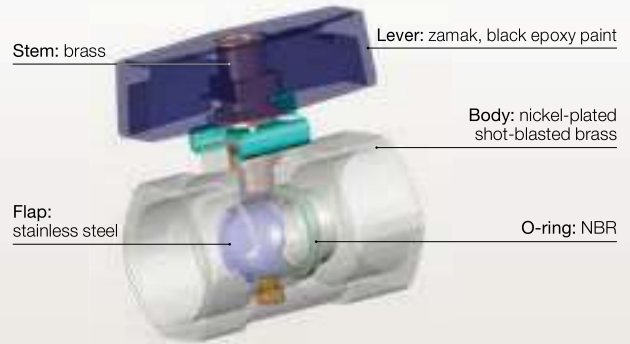

## Regulations

- PED
- REACH
- RoHS

## 4602 2/2 Butterfly Shut-Off Valve, Female BSPP Thread

Nickel-plated brass, NBR

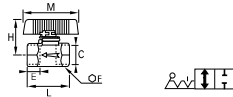

DN	C		E	F	H	L	M	Kg
6	G1/4	4602 06 13	9	17	35	34	54	0.102
7	G3/8	4602 07 17	11	22	35	39	54	0.136
10	G1/2	4602 10 21	12	24	37	42	54	0.140
13	G3/4	4602 13 27	14	30	40	49	54	0.208
18	G1	4602 18 34	15	41	46	55	54	0.412